

Commercial Stainless

ITEM # _____

QTY. _____

MODEL # CWTLM3/4

L-SHAPED WORKTABLE WITH MARINE EDGE TOP (3/4" RADIUS)

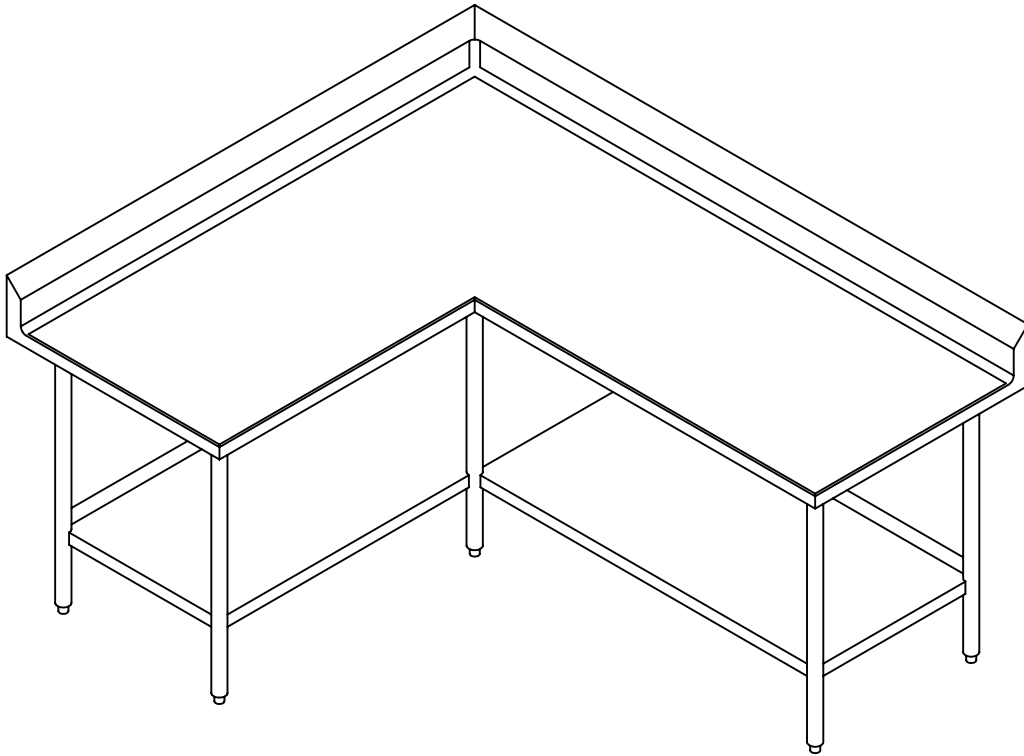

SPECIFICATIONS

WORKTABLE TOP TO BE 14 GA. TYPE 304, 18/8 STAINLESS LESS STEEL, POLISHED TO A # 4 FINISH. TOP EDGE TO HAVE 1 1/2" TURN DOWN WITH 1/2" RETURN. UNIT TO HAVE S/S CHANNEL STUD BOLTED TO TOP, WITH S/S LEG GUSSETS WELDED TO CHANNEL. LEGS TO BE 1 5/8" O.D. S/S TUBING WITH ADJUSTABLE S/S BULLET FEET. 16 GA. S/S UNDERSHELF TO BE NOTCHED & WELDED TO LEGS. UNDERSHELF TO BE TURNED UP 2" AT BACKSPASH LOCATIONS. ALL JOINTS TO BE CONTINUOUSLY WELDED, GROUND SMOOTH, & POLISHED. BACKSPASH TO BE TURNED UP ON A 3/4" RADIUS, 6" VERTICALLY, & BACK 2" ON A 45° ANGLE.

955 PATTERSON DRIVE
BLOOMSBURG, PA. 17815
TELEPHONE: (570) 387-8980 FAX: (570) 387-8982



CUSTOM BUILT
FOODSERVICE
EQUIPMENT 

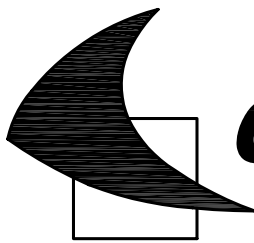

Commercial Stainless

ITEM # _____

QTY. _____

MODEL # CWTLM3/4

L-SHAPED WORKTABLE WITH MARINE EDGE TOP (3/4" RADIUS)

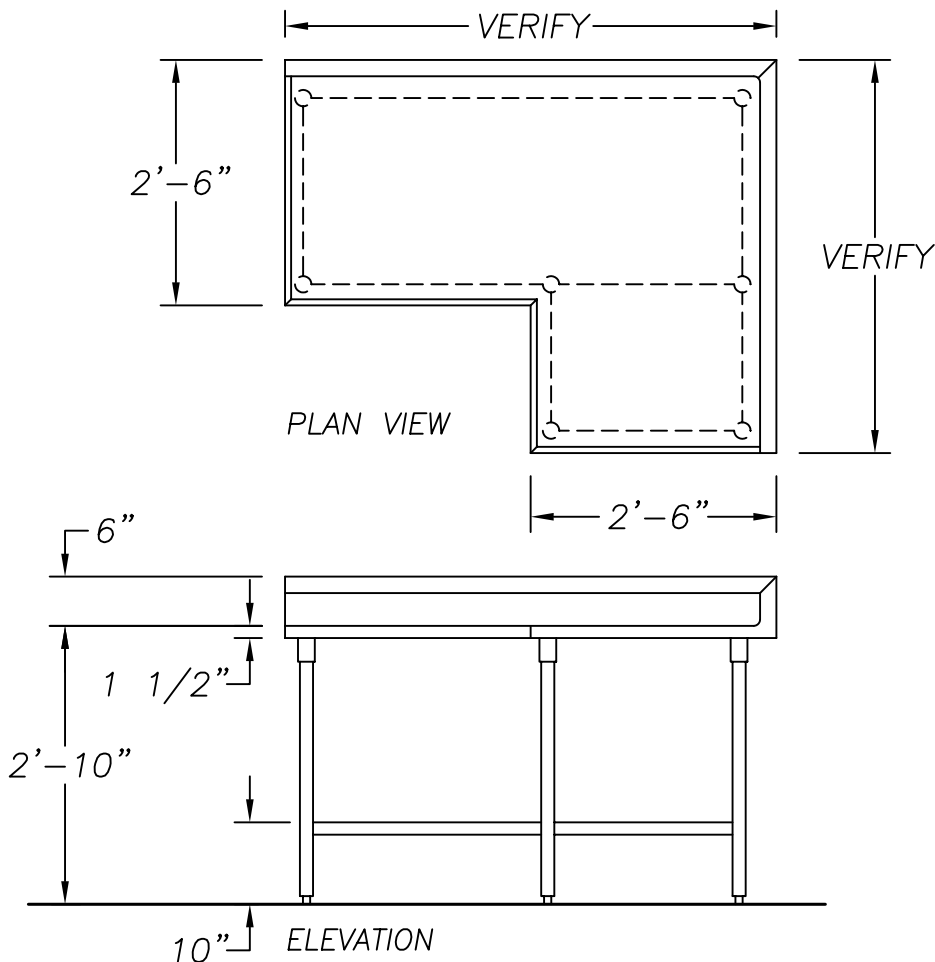

OPTIONS

- | | |
|----------------------------------|---------------------------|
| 1. 16 GA. S/S TOP | 2. SOUND DEADENING |
| 3. OPTIONAL UNDERSHELF | 4. DRAWER |
| 5. FLANGED FEET | 6. LEFT END SPLASH |
| 7. 1" O.D. S/S CROSSRAIL | 8. RIGHT END SPLASH |
| 9. 1 1/4" O.D. S/S CROSSRAIL | 10. SPECIAL SPLASH HEIGHT |
| 11. ___" X ___" X ___" DEEP SINK | 12. 1" THICK SPLASH |
| 13. OPTIONAL DRAIN | 14. URN TROUGH |
| 15. S/S WALL SPACERS | |